

Quick Start Guide: ULTRAPENx2™ PTBT1 with the Ultrapen PTBTX2™ APP

Conductivity / TDS / Salinity and Temperature Pen for Use with your Mobile Device

CHANGING THE PTBT1 SOLUTION MODE

1. Press and release the PEN BUTTON on the PTBT1 to turn it ON and place it into STANDBY Mode.
2. Tap the PREFERENCES button  in the Feature Navigation Bar.

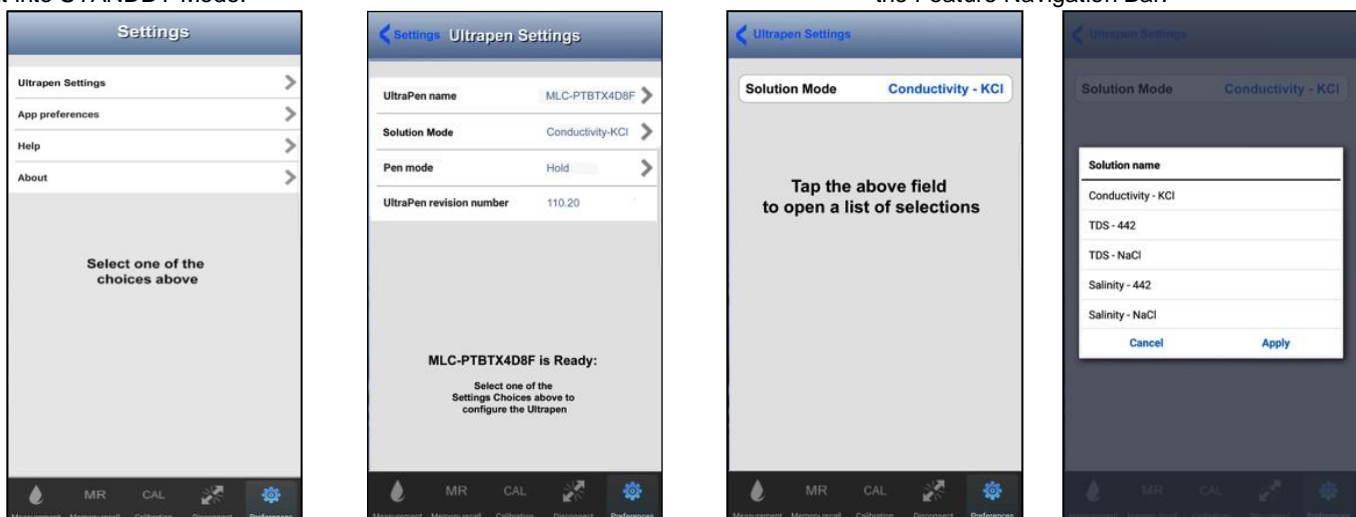

3. Tap the line that says **Ultrapen Settings**.
4. Tap the Solution Mode line on the screen.
5. The App will display the current Mode setting. Tap Solution Mode Field.
6. Select a Solution Mode from the list, then tap **APPLY**.

EXPORTING DATA RECORDS

1. Tap the **MEMORY RECALL**  button in the Feature Navigation Bar.
2. Tap the **EDIT** button in the upper right corner of the Record List. The Record List Edit screen will appear.
3. Tap individual records to select them for export, or tap the BLUE, **SELECT ALL** button to select the entire record list.
4. As you select records the **CLEAR** and **DELETE** buttons update to show the number of records selected.
5. Tap the **SEND** button in the upper left corner of the record list. The default email program for your mobile device will open.
6. An attachment will be present containing the selected records.
 - The format of the attachment will be either .csv (default), .xlsx or .xlsx.
 - The format for attachments can be changed by opening the **PREFERENCES > APPLICATION PREFERENCE** screen.
7. Complete the email in the standard manner for your email application.

MAINTENANCE

BATTERY REPLACEMENT

When the PTBT1 charge level falls below 25%, immediately replace the battery with a new N type battery.

1. In a **CLEAN DRY** place unscrew the battery cap in a counter-clockwise direction.
2. Slide the cap and battery housing out of the PTBT1.
3. Remove the depleted battery from its housing.
4. Insert a new battery into the battery housing oriented with the negative end touching the spring.
5. Align the groove along the battery housing with the guide bump inside the PTBT1 case and slide the battery housing back in.
6. Screw the PTBT1 battery cap back on in a clockwise direction. **Do not over tighten.**

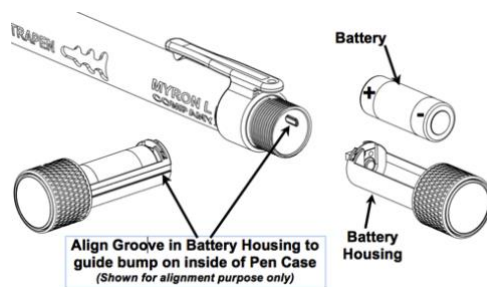

ROUTINE MAINTENANCE

- After each use **ALWAYS** rinse the cell with clean water (preferably DI, RO, or purified water).
- **ALWAYS** replace the Protective Cap on the cell after each use. **DO NOT** push the cap past the Cap Stop.
- Do not drop, throw, or otherwise strike the PTBT1.
- Do not store the PTBT1 in a location where the ambient temperatures exceeds its Operating/Storage Temperature limits.

MYRON L® COMPANY

2450 Impala Drive ♦ Carlsbad, CA 92010-7226 ♦ Phone: +1-760-438-2021
 E-Mail: Customer Service – info@myronl.com ♦ Technical Support – techquestions@myronl.com
 Website: www.myronl.com

Quick Start Guide: ULTRAPENx2™ PTBT1 with the Ultrapen PTBTX2™ APP

Conductivity / TDS / Salinity and Temperature Pen for Use with your Mobile Device

For more detailed instructions on making measurements, calibrating and maintaining the PTBT1, or changing settings and preferences download the full PTBTX2OM Operation Manual found on the Myron L® Company website (www.myronl.com), under the Downloads tab.

TO DOWNLOAD THE NEW PTBTX2™ APP



SYSTEM REQUIREMENTS

iOS device running iOS 10.0 or later.
 If you are using an iPad,
 Search for iPhone Apps

Android device running OS 7.0 or later.

ULTRAPENx2™ PTBT1 LAYOUT

1. **PEN BUTTON** – Press to turn the PTBT1 ON and place it in STANDBY Mode.
2. **BATTERY CAP** – Unscrew to change battery.
3. **LED INDICATOR LIGHT** – Flashes rapidly when the PTBT1 is MEASURING and once every 5 seconds when the PTBT1 is in STANDBY Mode.
4. **CONDUCTIVITY CELL** – Includes stainless steel conductivity electrodes and a temperature sensor.
5. **CAP STOP** – Pushing the protective cap beyond the cap stop may damage the cell.
6. **PROTECTIVE CAP** – Protects cell from damage when not in use.
7. **SCOOP** – Used to hold sample solution when dipping is not possible.

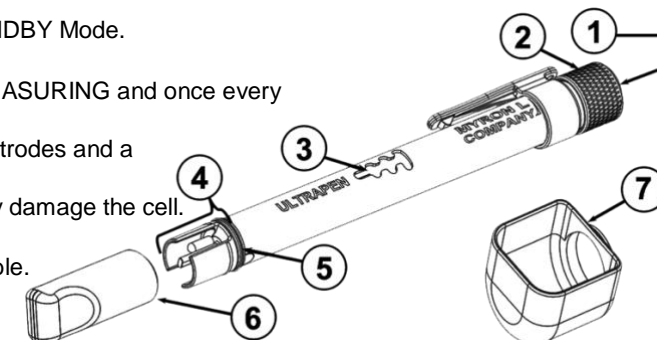

PTBTX2™ APP – FEATURE NAVIGATION BAR

This bar appears at the bottom of all screens. The buttons in this bar are used to navigate between the App's main functional areas.

- MEASUREMENT** – Returns the App to the Measurement screen.
- MEMORY RECALL** – Displays a list of saved measurements.
- CALIBRATION** – Places the App in Calibration Mode.
- CONNECT** – Opens the App's Bluetooth Connect / Disconnect screen.



- Once a PTBT1 is connected to the App the button label says Disconnect.
- PREFERENCES** – Opens the App's Preferences & Settings Modes, including an internet link to a full Operation Manual (**HELP**).

USING THE PTBT1

STEP 1 – CONNECT THE PTBT1 TO THE APP

1. On your Device's Home Screen, tap the blue **PTBTX2** icon.
2. Tap the **CONNECT** button at the bottom of the App display.
3. The App will switch to the **CONNECT** Screen.
4. Press and release the **PEN BUTTON** to turn PTBT1 ON.

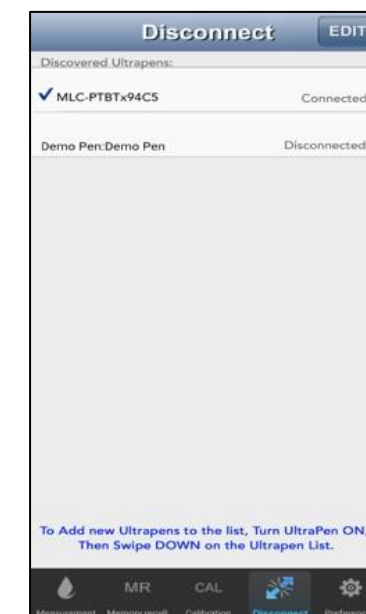
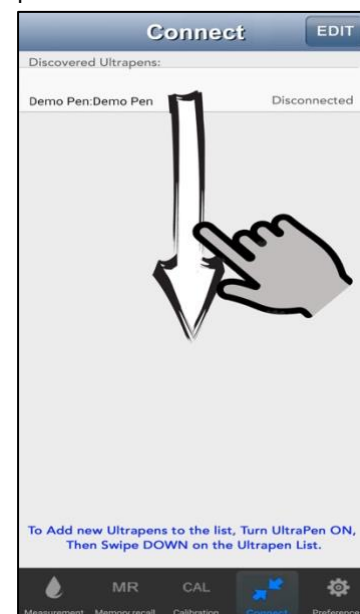

5. Swipe down on the screen. The PTBT1 will appear on the list.
6. Tap the PTBT1's name when it appears. Default: **MLC-PTBTX[Hexadecimal ID]**
7. The PTBT1 will move to the top of the list and a check mark will appear.

NOTES:

- Some Mobile Devices switch their wireless transmitters to a low power mode when their battery level gets too low. This could affect how easily your PTBT1 and your device connect and communicate.
- **ALWAYS** keep your Mobile Device Charge Level as high as possible.

Quick Start Guide: ULTRAPENx2™ PTBT1 with the Ultrapen PTBTX2™ APP

Conductivity / TDS / Salinity and Temperature Pen for Use with your Mobile Device

STEP 2 – MAKE A MEASUREMENT

1. Dip the PTBT1 cell in the Sample solution.

2. Tap the MEASUREMENT button  in the Feature Navigation Bar.

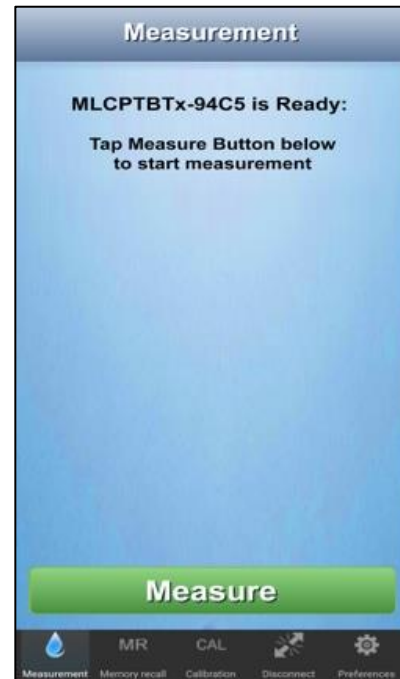

3. If the PTBT1 is OFF this screen will appear.

4. Press the button on the PTBT1.

5. If the PTBT1 is ON and in STANDBY Mode, this screen will appear. Tap the GREEN Measure button.

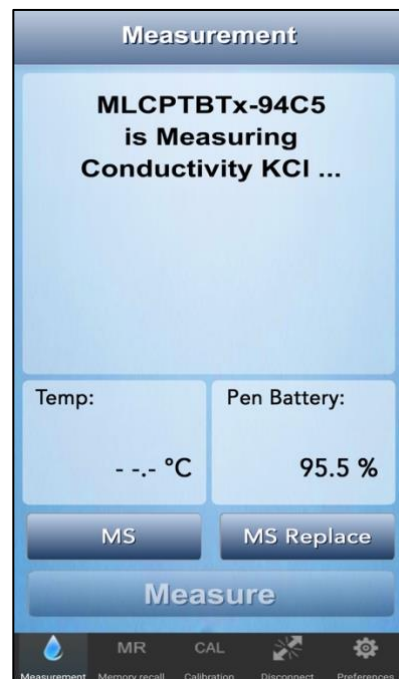

6. Swirl the pen in the sample while the PTBT1 is measuring. The PTBT1's LED will flash rapidly.



7. When the PTBT1 completes the measurement the App will display the values.

TO USE THE SCOOP

- Push the scoop onto the cell while shifting it gently side-to-side.
- Hold the scoop directly under a vertical sample stream while measuring. Avoid bubbles.
- To remove the scoop, pull it off while shifting it gently side-to-side.

MS Button

Tap to record the last measurement.

MS Replace Button

Tap to replace data in an existing record with data from the last measurement.

Quick Start Guide: ULTRAPENx2™ PTBT1 with the Ultrapen PTBTX2™ APP

Conductivity / TDS / Salinity and Temperature Pen for Use with your Mobile Device

CALIBRATING THE PTBT1

REQUIRED MLC CALIBRATION SOLUTIONS

PTBT1 Mode Setting	Conductivity KCL	TDS 442	TDS NaCl	Salinity 442	Salinity NaCl
MLC Calibration Solution	1800 μS	442™ 3000 ppm; Displays as 2027 ppm in NaCl Mode		442™ 3.000 ppt; Displays as 2.027 ppt in NaCl Mode	

1. Rinse the PTBT1 cell in Myron L® Company Calibration Solution.

2. Press and release the PEN BUTTON on the PTBT1 to turn it ON.

3. Tap the CAL button  in the Feature Navigation Bar.

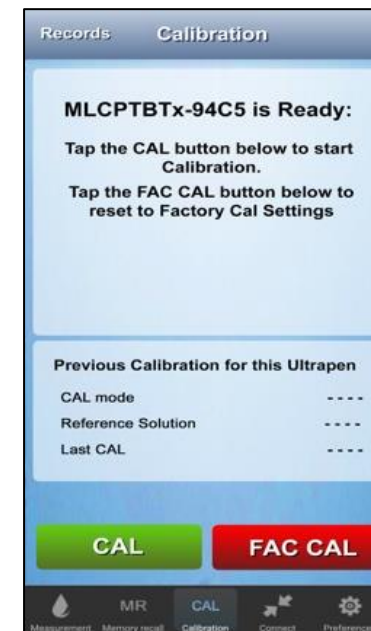

4. Tap the CAL button.

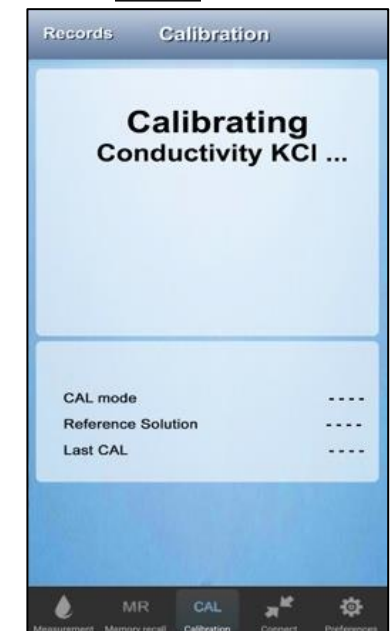

5. Swirl the pen in the Calibration solution while the PTBT1's LED is flashing rapidly.

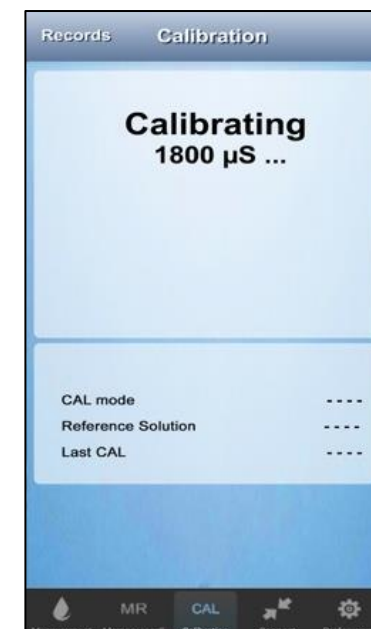

6. The PTBT1 will verify the Calibration Solution is correct.

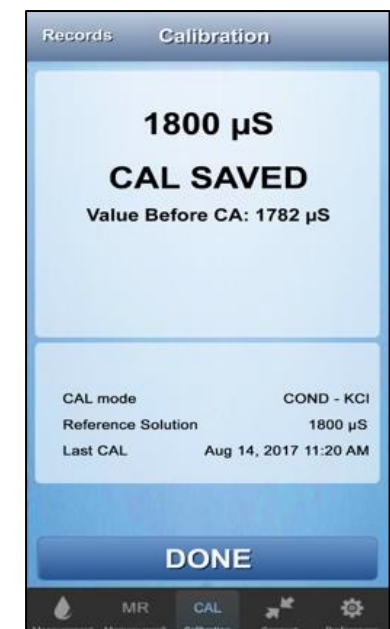

7. When the Calibration is done the App displays the values and saves a CAL record.

NOTE: FAC CAL resets the PTBT1 to factory settings, but **IT DOES NOT** account for current cell condition.